

SERVICEDRIVE®

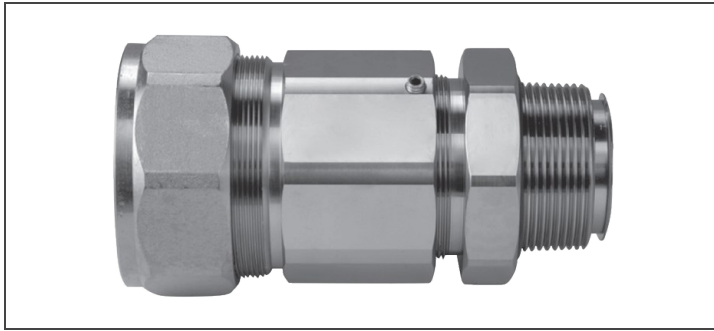

**VFD TERMINATING  
CONNECTOR**  
**Jacketed MC**  
1,000 Volt Copper



**Description:**

Patented connectors are designed exclusively to terminate VFD jacketed MC cables in control centers, panel boards, junction boxes, motors, and motor control enclosures.

**Application:**

\*Patented for use with ServiceDrive® VFD Cable Systems

**Standards:**

Hazardous Locations: Class I (Div 2) and Class II/III (all Divisions)  
NEMA 4  
IP65  
Thread Type: NPT

\*U.S. Patent No. 7,309,835

Part Number	3 Conductor Wire Size (AWG or Kcmil)	Hub Size	Set Screw Size
CONASD2K14/3	14	3/4"	10/32 x 1/4"
CONASD2K12/3	12	3/4"	10/32 x 1/4"
CONASD2K10/3	10	3/4"	10/32 x 1/4"
CONASD2K8/3	8	3/4"	1/4-20 x 1/4"
CONASD2K6/3	6	1-1/4"	1/4-20 x 1/4"
CONASD2K4/3	4	1-1/4"	1/4-20 x 1/4"
CONASD2K3/3	3	1-1/4"	1/4-20 x 1/4"
CONASD2K2/3	2	1-1/4"	1/4-20 x 1/4"
CONASD2K1/3	1	1-1/4"	1/4-20 x 1/4"
CONASD2K1/03	1/0	1-1/2"	1/4-20 x 1/4"
CONASD2K2/03	2/0	1-1/2"	1/4-20 x 5/16"
CONASD2K3/03	3/0	1-1/2"	1/4-20 x 5/16"
CONASD2K4/03	4/0	2"	1/4-20 x 5/16"
CONASD2K250/3	250	2"	5/16-18 x 3/8"
CONASD2K300/3	300	2"	5/16-18 x 3/8"
CONASD2K350/3	350	2-1/2"	5/16-18 x 3/8"
CONASD2K400/3	400	2-1/2"	5/16-18 x 3/8"
CONASD2K500/3	500	2-1/2"	5/16-18 x 3/8"
CONASD2K600/3	600	3"	5/16-18 x 3/8"
CONASD2K750/3	750	3"	5/16-18 x 3/8"